

Exploring trajectories of coupled human-nature systems: a comparative analysis of tropical forest Social-Ecological-Systems

Driss Ezzine-de-Blas (CIRAD)
Cecilia Viana (USP)
Emilie Coudel (CIRAD)
Eline Enfors (SRC)
OTHERS?

Anderies et al. 2004

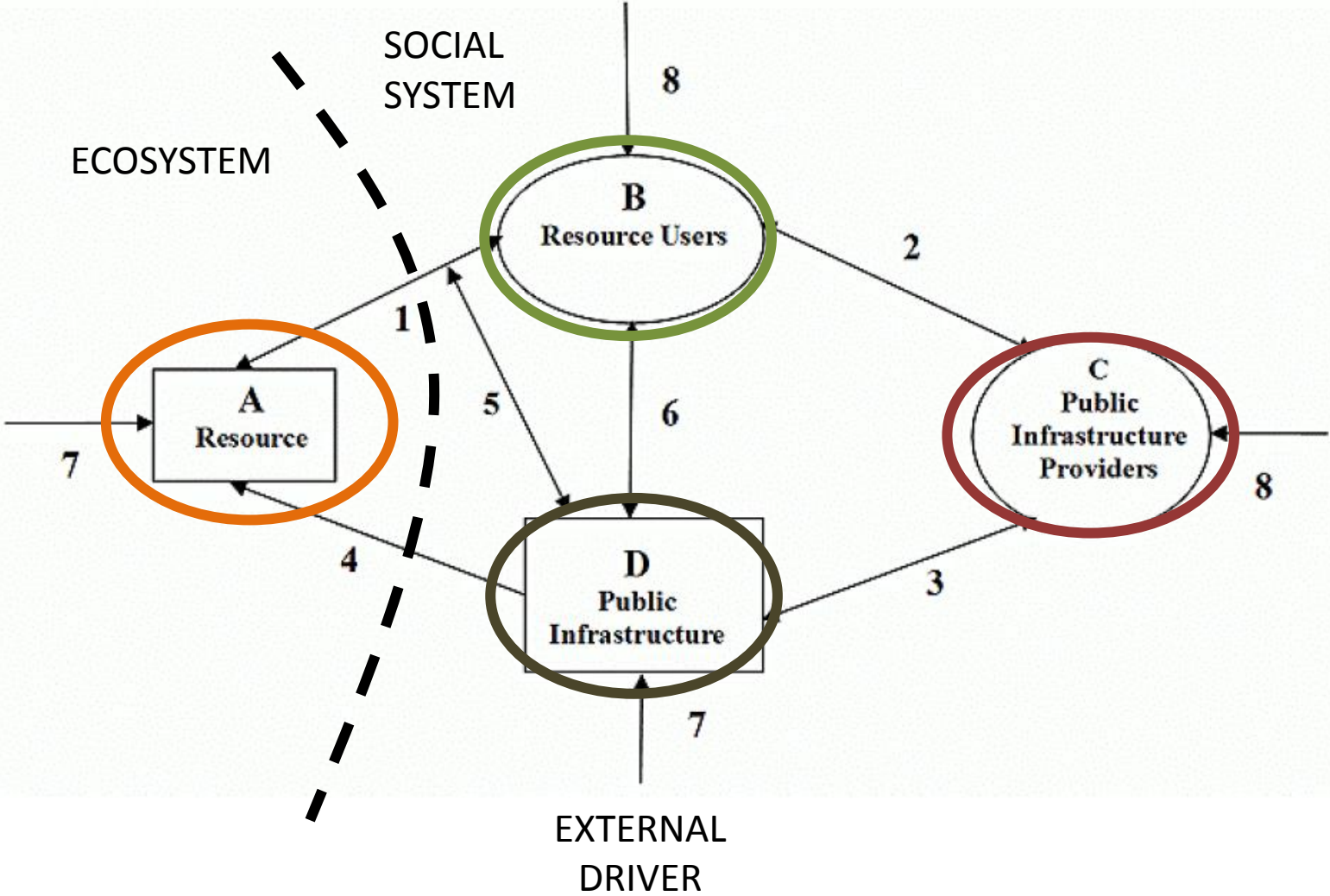

Regional social-ecological system

Carpenter et al. 2007

ECOSYSTEM

Ecosystem dynamics:
hydrology,
biogeochemistry,
biota

Policy and practice:
land use,
agriculture,
fisheries, water
quality, invasive
species

Human uses:
Agriculture,
industrie,
municipal uses,
fishing, lake-related
businesses,
recreation

External drivers:
Atmospheric fluxes and
climate,
Economic, political and
social context

SOCIAL
SYSTEM

Social dynamics:
Demography, farm
economics,
demand for lake
and shoreland
resources

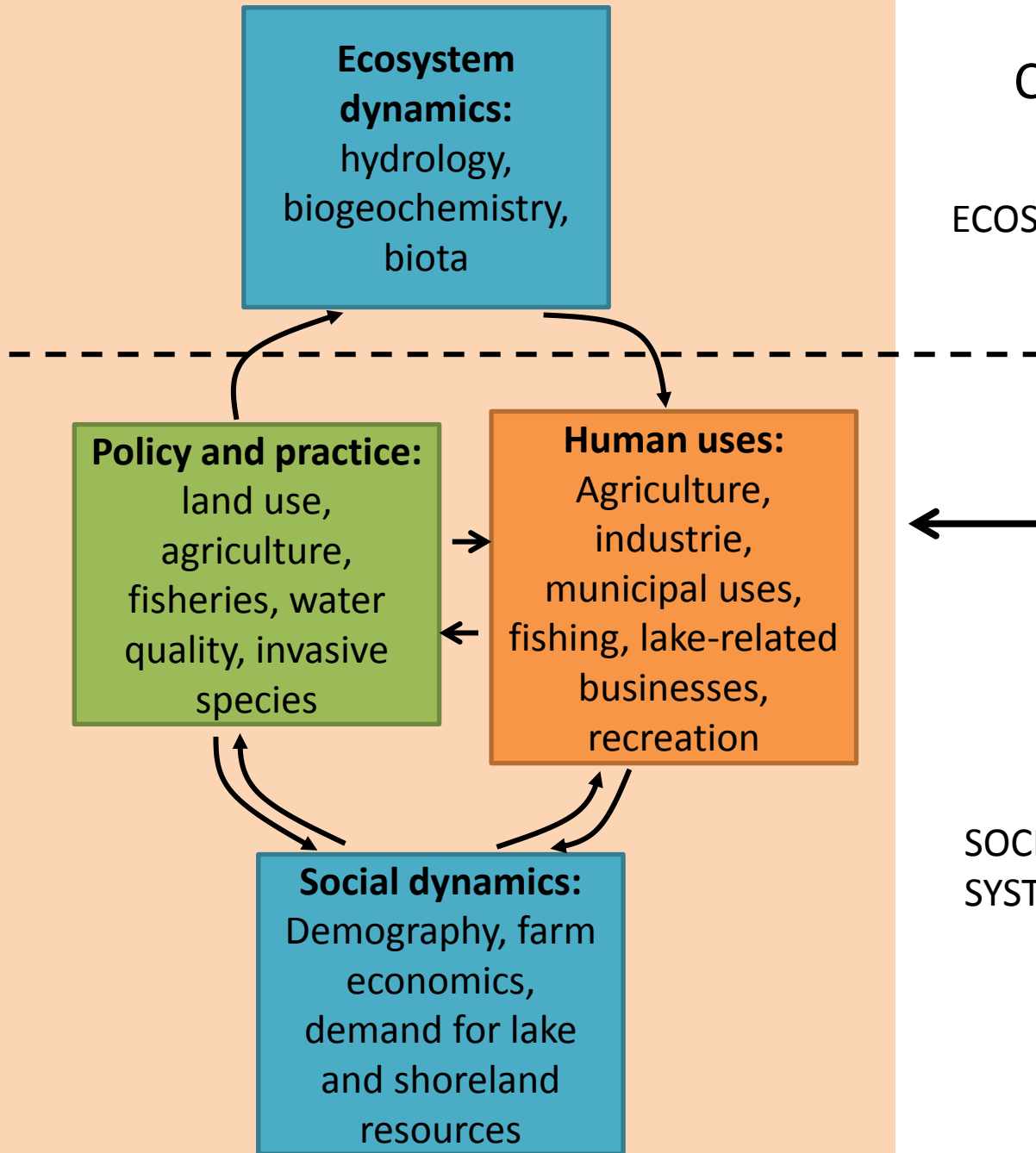

Garcia 2009

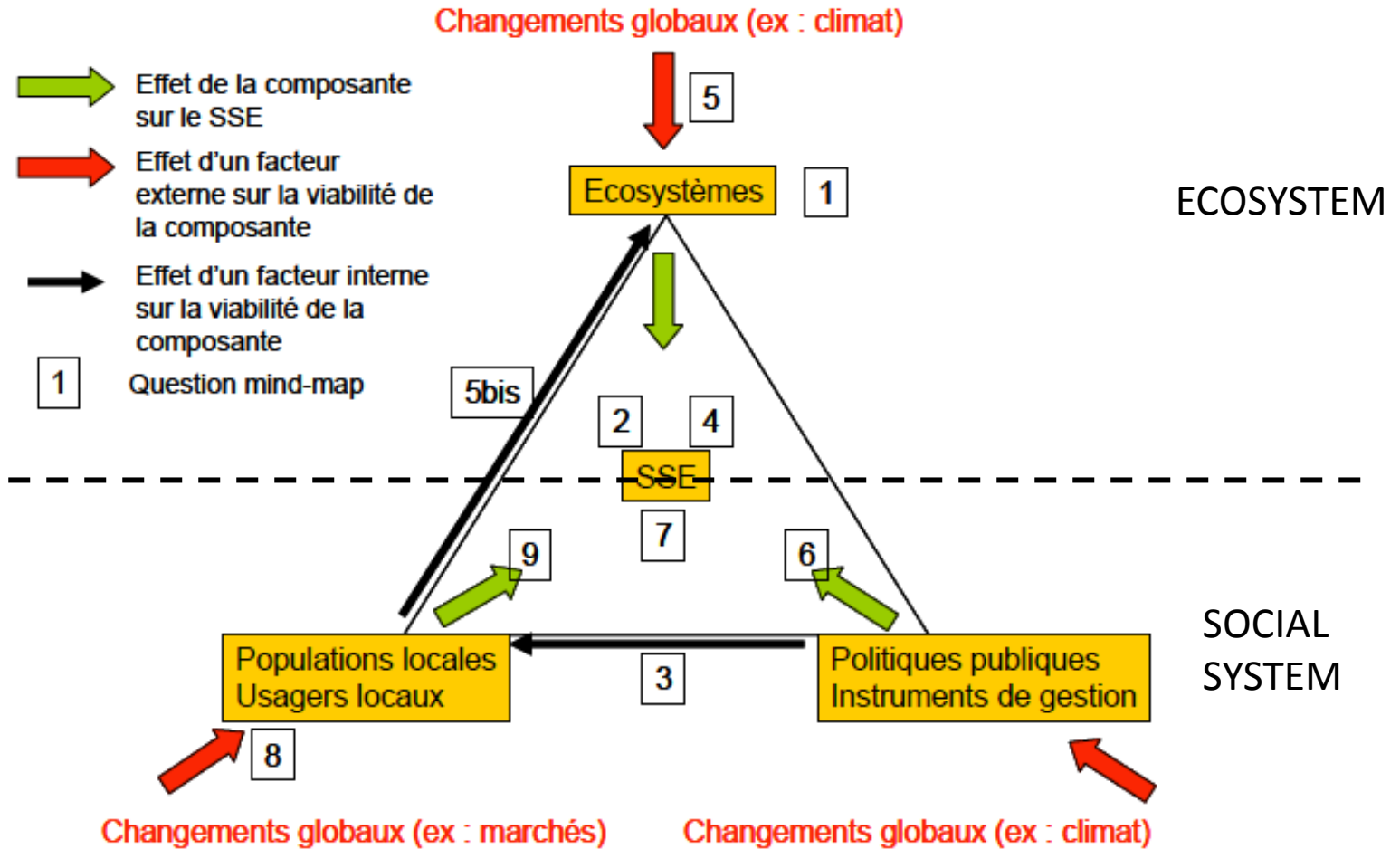

Ostrom 2009

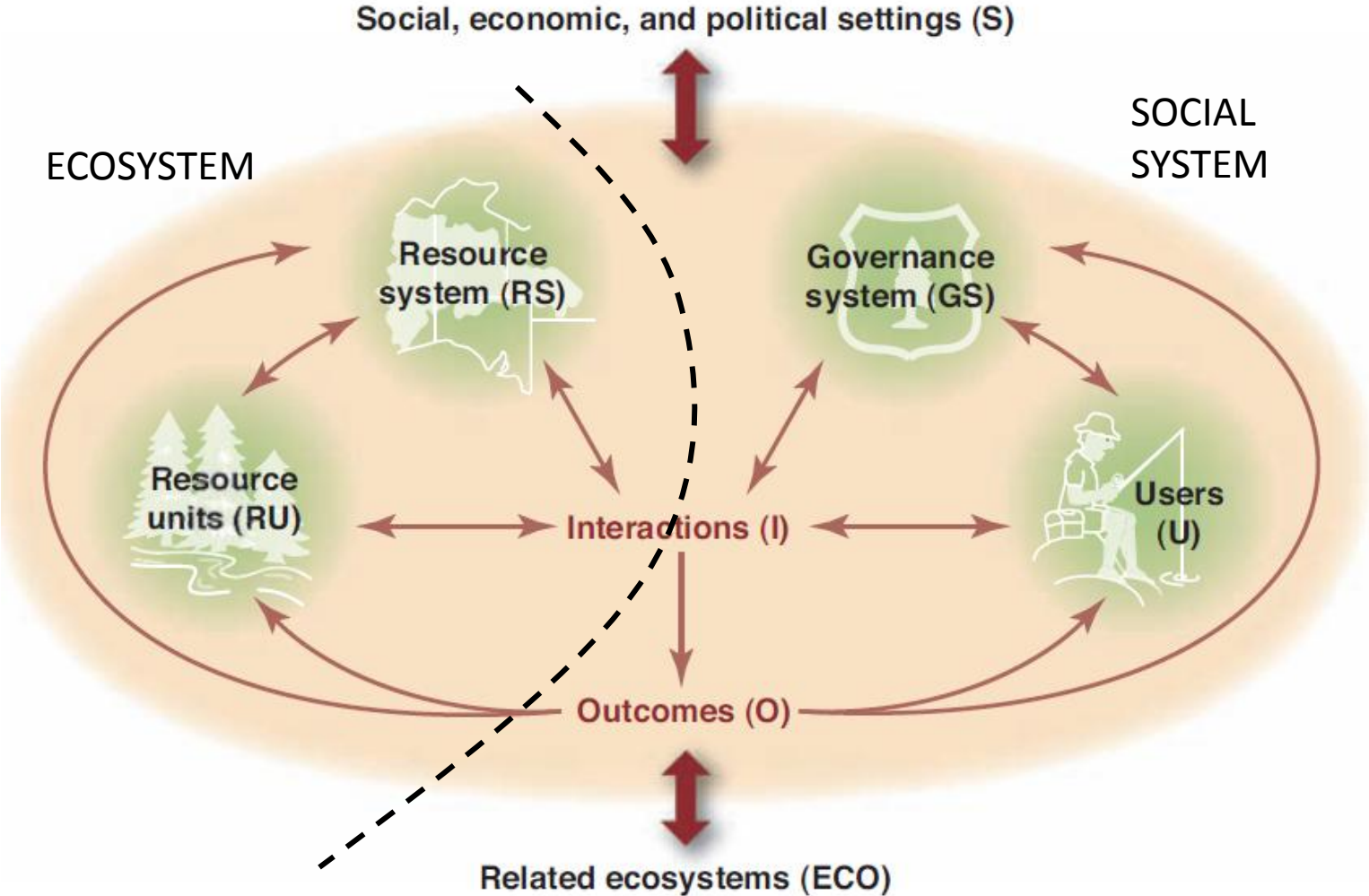

Social, economic, and political setting (S)

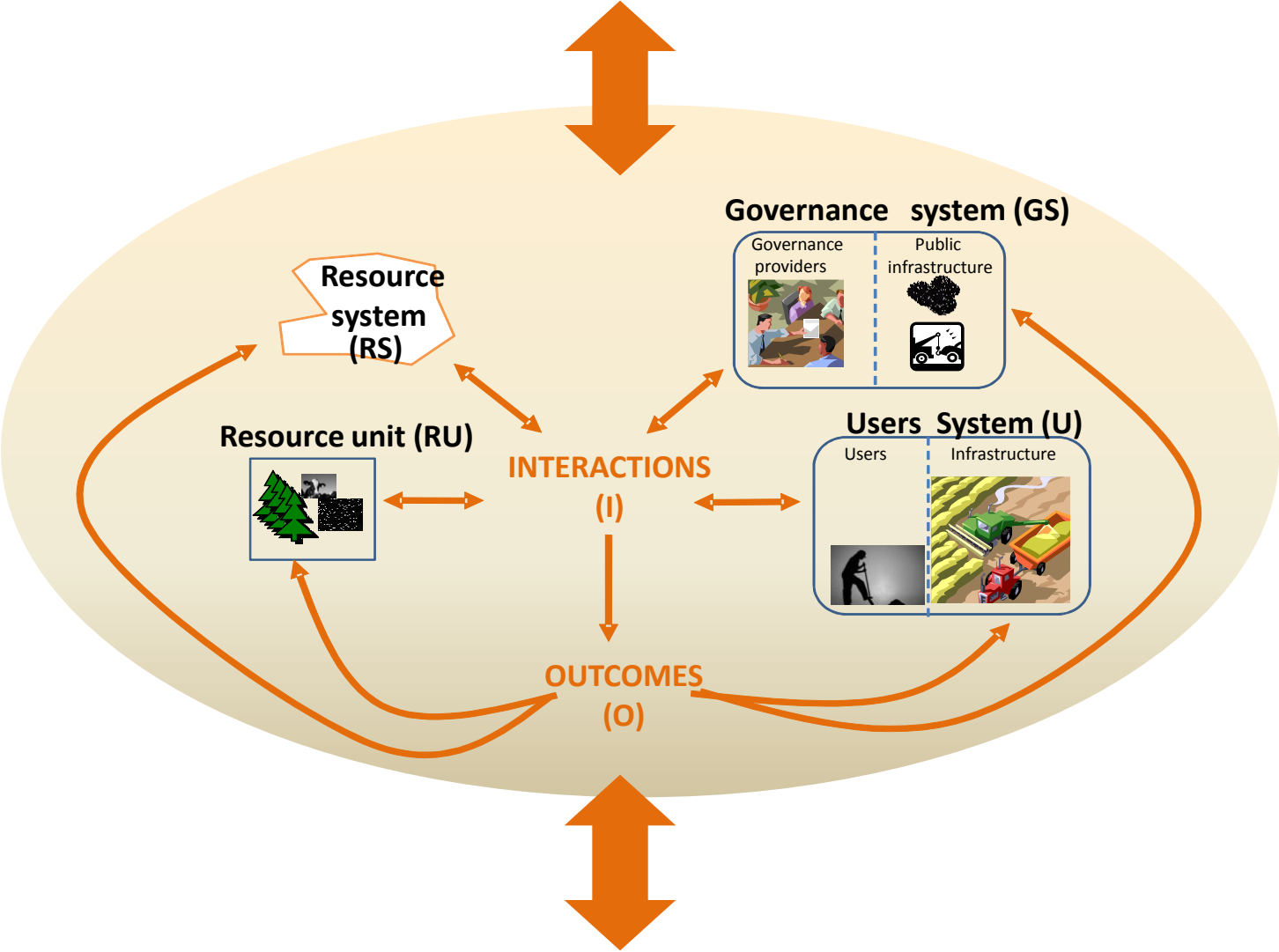

Related SES (SECO)

Objectifs

1. Définir sub-systèmes (terrains)
2. Définir variables clés (identité du sub-système)
3. Décrire des trajectoires empiriques
4. Explorer les interactions linéaires et non-linéaires qui expliquent ces trajectoires et changement de régime

Conservation

Abattis-brûlis

Intensification



T

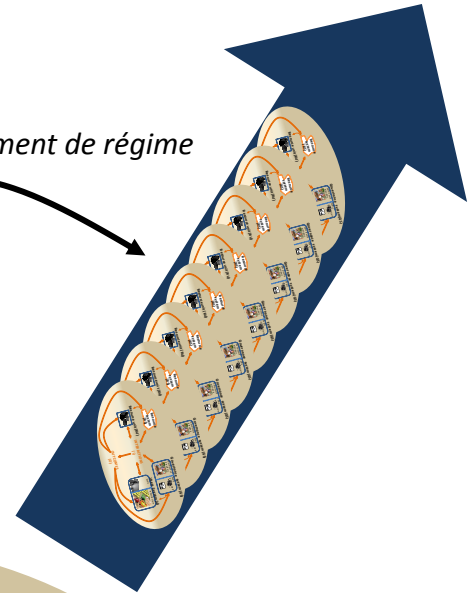
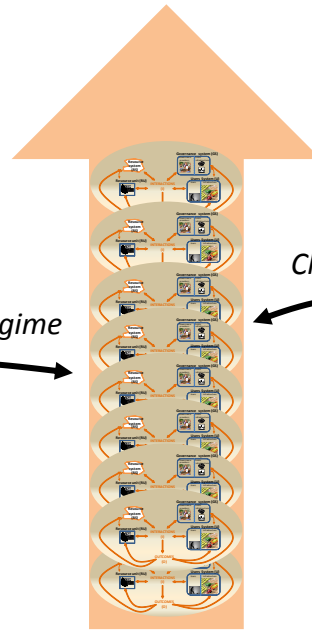
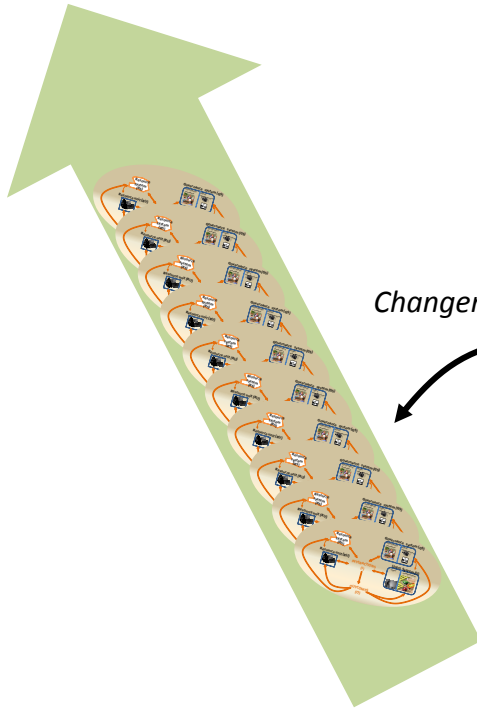

Changement de régime

Changement de régime

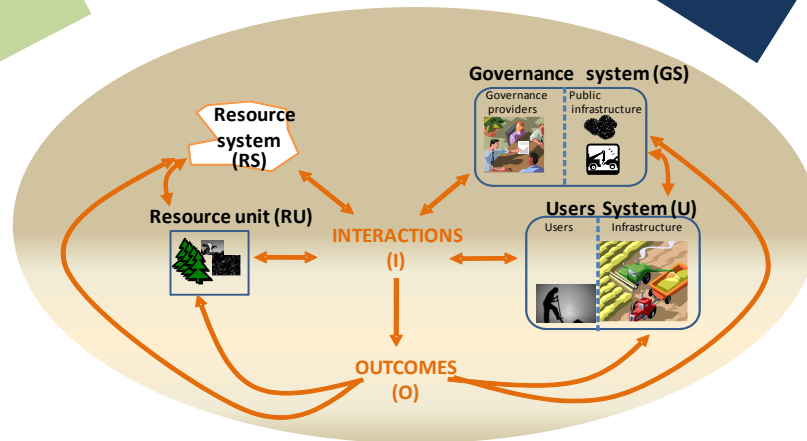

Analyse quantitative

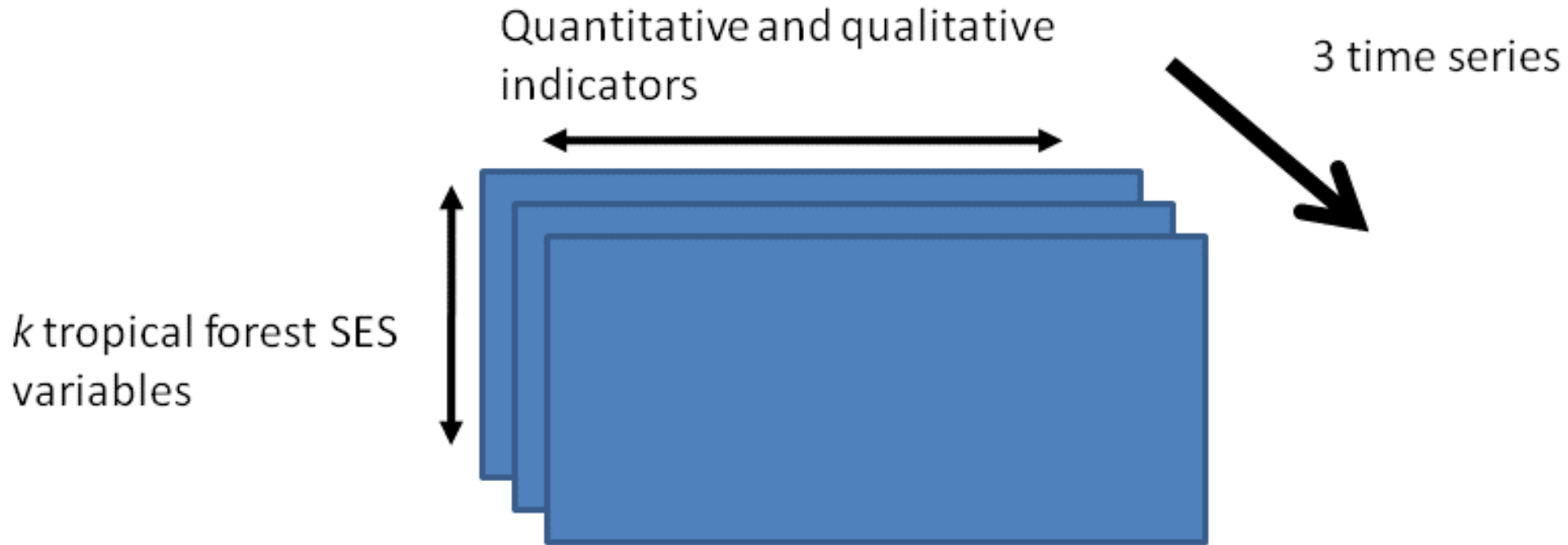

Commentaires

- Méthodologique:
 - Evidence de trajectoires?
 - Evidence de changements de régime?
 - Choix des variables clé
 - Analyse quantitatif et qualitatif
- Organisationnel:
 - Terrains pertinents et chercheurs intéressés
 - Données disponibles mais à relier

- Créer des espaces pour réfléchir et valoriser les terrains en commun:
 - Court terme: publication/ special issue
 - Différentes vitesses: projets régionaux vs comparaisons inter-terrains
 - Autres